

KENDRIYA VIDYALAYA SANGATHAN

(Jabalpur Region)

Sports Cell



तत् त्वं पूषन् अपावृणु
केन्द्रीय विद्यालय संगठन

Study Material for Sports Quiz

(Brief Descriptions of Selected Games & Sports)

2020-21

Contents

S No	Games / Sports	Page No
1	Athletics	1
2	Football	2
3	Basketball	3
4	Hockey	4
5	Volleyball	5
6	Kabaddi	6-7
7	Kho-Kho	8
8	Badminton	9
9	Cricket	10
10	Table-Tennis	11-12
11	Yoga	13
12	Modern Olympic Games	14
13	Sports Awards in India	15
14	Diagrams of `Play grounds/Courts	16-21

ATHLETICS

Modern Track and Field was started in England in 1800 A.D. In 1880, Oxford and Cambridge Universities Established Amateur Athletics Association. First International competition was organized in New York in 1895. The Amateur Athletic Federation of India was established in Bangalore in 1946.

Specifications of the Playfield & Sports Equipments:

1. Weight of Shot :	7.260 kg (men)	4 kg (women)
2. Weight of Discus:	2 kg (men)	1 kg (women)
3. Weight of Javelin:	800 gm (men)	600 gm (women)
4. Weight of Hammer:	7.260 kg (men)	4 kg (women)
5. Angle of throwing sector (Shot put, Discus, Hammer):	34.92 ⁰	
6. Angle of throwing sector (Javelin):	29 ⁰	
7. Inside diameter of the circle (Shot put and Hammer):	2.135 m	
8. Inside diameter of the circle (Discus):	2.50 m	
9. Length of runway (Long Jump, Triple Jump and Pole Vault):	40 m	
10. Length of landing area (Long Jump & Triple Jump):	9 m	
11. Width of landing area (Long Jump & Triple Jump):	2.75 m	
12. Take-off board away from the landing area:	13m (men)	11m (women)
13. The length of runway with a radius from centre of pit:	15-20 m	
14. Width of runway (Long Jump, Triple Jump and Pole Vault):	1.22 m	

Knowledge at a glance:

1. Length of standard track:400 m
2. Short distance races: 100m, 200m, 400m, 4X100m relay, 4X400m relay
3. Medium distance races: 800m 1500m
4. Long distance races: 3000m steeplechase race, 5000m, 10000m and marathon race.
5. Hurdle races: 110m hurdle (men), 100m hurdle (women), 400m hurdle (men & women)
6. Command used for short distance races, relay races & Hurdle races: ON YOUR MARK, SET, GUN SHOT.
7. Command used for medium distance races & Long distance races: ON YOUR MARK, GUN SHOT.
8. Starting line is included in all races measurement and finishing line is excluded.
9. Name of Techniques of performing various events Skills:
 - Shot put: Parry O Brien technique
 - Discus Throw: Running Rotation Technique
 - Long Jump: Hang Technique, Cyclic Technique
 - High Jump: Fosbury Flop

FOOTBALL

Football is also known as Soccer. The modern version of game came from England in 1848. The first recorded match was played in 1872 between England and Scotland. Federation International de Football Association (FIFA) was formed in 1904 which regulates the rules and development of football.

Rules of the Game

- 1 The objective of soccer is to send the ball into the opposing team goal, by propelling it with feet or any part of the body but not with the arms or hands.
- 2 Two teams, with a maximum of 11 players each (1 goalkeeper and 10 field players) play
- 3 Two halves of 45 minutes period each is the time.
- 4 Game is started with push-pass in opponent's field from centre circle.

Specifications of the Playfield & Sports Equipments:

1. Ground dimension: 90-120m(length) & 45-90 m(width)
2. Weight of football: 410-450 gm
3. No. of players in team: 18 (11 playing and 7 substitutes)
4. Duration of match: 2 halves of 45 minutes (M) and 40 minutes (W)
5. Goal post dimension: 7.3m X 2.44m with 5 inch thickness of post.
6. Width of line: 12 cm
7. Centre circle radius: 9.15 m
8. Corner arc: 91 cm at corner
9. Penalty point: 11 m from goal line
10. Goal line: 5 inches

Important tournament:

FIFA world Cup, Euro Cup, Olympic Games, Durand Cup.

BASKETBALL

Dr. James Naismith was a physical education teacher in YMCA Training school at Springfield (USA). He invented this fast paced offensive game in 1891. It was officially introduced in 1936 Berlin Olympic Games. At world level its rules and technicalities is regulated by “Federation International de Basketball Association (FIBA). In India basketball is regulated by “Basketball Federation of India (BFI)” and it was constituted in 1950.

Rules of the Game:

1. Two teams of 5 players each try to score points by tossing the ball into the opposing team’s basket.
2. A field goal counts for 2 points or 3 points (if it is thrown from outside the 3-point line). A free throw is worthy of 1 point. This is indicated by raising one or two or three fingers of right hand by Referee.
3. After taking possession of the ball, it has 8 second to move the ball forward across the mid-court line; 24-second to take a shot at the basket.
4. The playing time period is of 40 min duration which is extended into four quarters. The rest period in between I to II and III to IV quarters is 2 min, whereas, in half (between II to III quarter) is 5 min. to 10 min.
5. 5-second rule: A player cannot hold the ball (without bounce) for more than ‘5’ second.
6. 3-second rule: any offensive player cannot stay inside the opponent’s restricted area consecutively for more than ‘3’ seconds.

Specifications of the Playfield & Sports Equipments

- | | |
|---------------------------|---|
| 1. Total players in team: | 12(5 field players and 7 substitutes) |
| 2. Area of court: | 28m X 15 m (excluding lines 5 cm) |
| 3. Radius of circles: | 1.80m |
| 4. Height of board: | 2.90m from surface |
| 5. Backboard: | 180 cm X 105 cm |
| 6. Diameter of ring: | 45 cm |
| 7. Weight of ball: | 625 gm |
| 8. Duration of game: | 40 min in four quarters (10 minutes each) |
| 9. Time out: | 1 min duration |

Important Tournament:

Olympic Games, World Championship, NBA (League)

HOCKEY

The Blackheath club in London was the first to be founded in 1861 and the official matches were played. Men's field hockey was an event in the 1908 London Olympics; women's field hockey became an Olympic event only in 1980. The Federation of International Hockey (FIH) was founded in 1924 by seven European Countries. In India it started from Gwalior in 1924. The Indian Hockey Federation (IHF) was formed in 1925 at Gwalior. India participated first time in 1928, 'Amsterdam Olympic' where it won first-ever Gold medal in Olympic Games.

Rules of the Game:

1. Two teams (11 players each) play two halves of 35 minutes for men and 30 minutes for women, with a 5-10 minute rest in half time.
2. Each team has 1 goalkeeper and 5 substitutes who can enter at any time (except during penalty corners).
3. The goal is only scored from the inside of shooting circle (D).
4. The goalkeeper can use hands and legs (protective wear) but cannot hold the ball.

Specifications of the Playfield & Sports Equipments

1. Length of the playfield: 91.4m including lines of 5 cm width.
2. Breadth of the playfield: 54.85m including lines of 5 cm width.
3. No. of players in a team: 16 (11 field players and 5 substitutes).
4. Duration of the game: 2 halves of 35 min(men), 30 min (women)
5. Substitutes allowed: Rolling substitution, any number of substitutions.
6. Weight of ball: 156 gm
7. Weight of sticks: 16 to 32 ounce.
8. Penalty stroke position: 6.4 m from goal line
9. Dimension of goal post: 3.66m X 2.14m of 5 cm thick wood.
10. 'D' (Shooting circle): 14.63m
11. Type of surface: Astro turf, Grassy, Clay

Important Tournament:

Olympic Games, World Championship, Asian Games

VOLLEYBALL

In 1895, William G. Morgan invented this indoor game, called “Mintonette”, which later become Volleyball. Volleyball was a demonstration sport in 1924 Olympic Games (Paris) and became an official sport in 1947 when the Federation International de Volleyball (FIVB) was founded. In 1949, first men’s World Championship was played in Prague (CHZ). Volleyball was part of the Olympic Games in Tokyo (1964).

Rules of the Game:

1. A set is won by a score of 25 points
2. The team that wins a rally wins a point, moreover, wins the right to serve at the same point.
3. If there is a tie at 24 points or at 14 points (in final game) then game continues until one team has a 2 point lead.
4. A match is won by 3 sets (out of 5). Fifth set for men and third set for women is of 15 points.
5. The rally ends when the ball touches the ground or when it is hit out of bounds or when the player does not return it legally.
6. When a team wins service, the players rotate one position clockwise.
7. Each team can touch the ball maximum of 3 times in addition to the block, before sending it into the other team’s court. Once a player has touched the ball, he cannot touch it again until it has been touched by another player in either team.

Specifications of the Playfield & Sports Equipments

1. Volleyball playfield: 18m X 9 m
2. Length of service line: 9m
3. Size of net: 9.5m X 1m (width)
4. Height of net: 2.43m (men), 2.24m (women)
5. Pole to pole distance: 10m to 12m
6. Height of antenna: 80cm above net (over side line)
7. Weight of the ball: 270gm
8. No. of players: 12 (6 playing and 6 substitutes including libero)
9. Width of line: 5cm
10. No. of points in a set: 25 points lead of two points, 15 points in fifth set (men) or third set (women).

Important tournament:

Olympic Games, World Volleyball Championship, Asian Games.

KABADDI

Kabaddi is the most popular rural game of India. It can be played anywhere and anytime. It is played in a not so big rectangular plot or ground between two teams of 7 players.

In ancient time kabaddi was popularly known as do-do. In Mahabharata time it was call 'EkShwas' (one breath). In rural India it was and is still known by different names, such as hu-tu-tu, goddoo-goddoo, hadudu etc. in 1923 rules for Kabaddi were framed, and in the same year, the first All India Kabaddi Competition was held in Vadodara. Indian Kabaddi Association was established in 1951. Kabaddi was included in the Asian Games in 1982, though it was an exhibition game in 1936 Berlin Olympic Games, it has been included in the Olympic.

Rules of the Game:

- 1 Two points are awarded for a LONA.
- 2 A player cannot apply oil or any soft, slippery substance on his body.
- 3 Nails of the all players must be closely clipped.
- 4 All the players must wear distinctly numbered T-shirt.
- 5 In case of a tie two extra-time of 5 minutes are given just after the match. If the match is still a tie then teams scoring leading point at the end of two extra halves, wins.
- 6 Bonus points are given only when the opponents have at least 6 players.
- 7 Only 3 substitutions are allowed for each team.
- 8 A team must send its raider within 5 seconds of the opponents raider's return to his half or if he is out.
- 9 Toss decides which team is to choose court or which team is to choose raid.
- 10 When all the players of team are out, the points of 'Lona' are awarded to the opponents.

Specifications of the Playfield & Sports Equipments

Dimension of the playfield of kabaddi	
For men or senior	13x10m
For women and juniors	12x10m
For mini or sub junior girls and boys	11x8m
Width of the lobby	1 m
Distance of the centreline from baulk line (men)	3.75m
Width of the centre line and other lines	5 cms
Size of the block for men	1x8 m
Size of the block for women and juniors	1x6 m
Numbers or players in each team	12
Numbers of players who take part in a match	7
Duration of match for men	Two halves of 20 min. each
Duration of match for women and juniors	Two halves of 15 min. each
Period of interval	5 min.
Officials (Referee 1, Umpire 2, Scorer 1, Timekeeper 1, Linesmen 2)	7

Important tournament:

- 1 Asian Games: introduced in 1990 Beijing games.
- 2 Asian Championship: started in 1980 at Calcutta.
- 3 World Cup
- 4 Federation Cup: started in 1981 at Chennai.
- 5 National Games.
- 6 Gold Cup, Mumbai

KHO - KHO

KhoKho is a very popular Indian game among young people. It is played in a rectangular field between two teams of 9 players each. It has two innings of 9 minutes each.

This game was originated in Poona (Maharashtra) and developed in Akharas and Vyayamshalas in state. Hanuman VyayamPracharakmandal, Amravati (Maharashtra) provided a new forms to this game. It was first introduced in 1928, by AkhilMaharashtraSharirikShikshanMandal. KhoKho Federation of India (KKFI) was formed in 1960. It was first introduced for demonstration in 1982 in Asian Games which were held in Delhi.

Rules of the Game:

- 1 The running or chasing is decided by toss.
- 2 The captain of chasing side may end the turn before allotted time.
- 3 The side scoring more points wins.
- 4 When a defender is out, he enters the sitting Box from the lobby.
- 5 A match consists of two innings of chasing and defending turns.
- 6 A defender shall not touch a sitting chaser. If he does so, he shall be warned once. If he repeats the same, he shall be declared out.
- 7 The length of the khokho court has been changed to 27 metre and width to 16 metre. The distance from pole to pole has been changed to 24 metre.
- 8 Any eight chasers shall sit on the square facing the side lanes in such a way that no adjacent chasers face the same side lane. The active chaser shall stand in the either of the rectangles to start that pursuit.

Specifications of the Playfield & Sports Equipments:

Total area including lobby	30x19 m
Playfield (length & Breadth)	27x16 m
Free Zone	1.50m x 16 m
Centre lane	24m x 30 cm
Cross lane	16m x 35 cm
Distance between last line and 1 st cross line	2.55 m
Each court divided by the centre line	7.85 m
Squares	8 squares (35 cm x 30 cm)
Posts	Two strong wooden posts shall be fixed. Height of the post 1.20 m, circumference 30 cm to 40 cm.

Important tournament:

- 1 Asian championship
- 2 NetajiSubhash International Tournament
- 3 National Kho-Kho Championship for men.
- 4 National Kho-Kho Championship for women.
- 5 Nehru Gold Cup

BADMINTON

Badminton is a racquet sport played using racquets to hit a shuttle cock across a net. Although it may be played with larger teams, the most common forms of the game are "singles" (with one player per side) and "doubles" (with two players per side).

The game of badminton was started in the nineteenth century in England. But it flourished in India during the British period when some army officers used to play it in Pune. The rules for the game were formed in Pune in 1870. The International Badminton Federation was constituted in 1934. India also became its member in 1938.

Rules of the Game:

- 1 The winner of toss decides to pick an end or to choose between serving or receiving first.
- 2 The match consists of the best of three games. Any player or team winning two games is declared the winner.
- 3 All games consist of 21 points. The points can be scored only by the player or team which serves.
- 4 The colour of the net is dark and its mesh is 15-20 mm.
- 5 In 'Singles play' the player shall serve or receive in his respective right hand service court only, when the server's score is '0' or even number of points in the game, and in case of odd number of points, the player shall serve or receive from left hand service court.

Specifications of the Playfield & Sports Equipments:

Court:	size for singles	=	13.40 m X 5.18 m
	Size for doubles	=	13.40 m X 6.10 m
	Short service line from Centre line	=	1.98 m
Net:	Width of the net	=	2 feet 6 inches
	Height of the net from Centre	=	5 feet
	Height of the net from poles	=	5 feet 1 inch
Shuttle:	Weight of shuttle	=	4.73 gm to 5.50 gm.
	No of feathers in shuttle cock	=	14 to 16
	Length of feather	=	6.4 cm to 7 cm
Racket:	Overall length	=	27 inches/680 mm
	Length of head	=	11 inches/290 mm
	Overall width	=	9 inches/230 mm
	Weight	=	85 gm to 140 gm
Points:	Men & Women both	=	21 points

Game: Best of three

Officials: 7 (Referee-1, Umpire-1, Senior Judge-1, Linemen-4)

Important tournament:

1	Olympic Games	4	All England Championship
2	Thomas Cup (World Team Men)	5	Asian Games
3	Uber Cup (World Team Women)	6	Commonwealth Games

CRICKET

The Malbourne Cricket Club (MCC) at Lords (formed in 1787), became the reference for the code of ethic employed in cricket. The MCC gave proper shape to cricket by framing rules and regulations in 1835. Imperial Cricket Conference was formed in 1989 to regulate its development which became International Cricket Conference ICC in 1952. Cricket is administered worldwide by the International Cricket Council (ICC), which organizes the ICC trophy every 4 years. The first World Cup was held in 1975.

The first Indian Cricket Club was named as Orient Club Mumbai in 1848. India's first official match was played in 1933 at Gymkhana ground in Mumbai. India had won the World Cup in 1983 under the captainship of Kapil Dev.

Rules of the game:

1. Two teams of 11 players each play alternately on the elliptical field. There is a rectangular strip (the pitch) located between stumps in the centre. The choice of the team batting or fielding is determined by a toss.
2. The bowler bowls the ball towards the wicket in order to make the balls fall off the wicket (called breaking the wicket). If he succeeds, the batsman is out.
3. A run is completed when the 2 batsmen cross each other and reach their opposite ends.

Specifications of the Playfield & Sports Equipments:

- | | |
|--------------------------------|---------------------|
| 1. Players in a team: | 11 + 5 (extra) = 16 |
| 2. Weight of the cricket ball: | 156gm |
| 3. Circumference of the ball: | 22.5cm |
| 4. Length of bat: | 96.5cm |
| 5. Distance between stumps: | 20.12m |
| 6. Height of stumps: | 71.1cm |
| 7. Breadth of stumps: | 22.8cm |
| 8. Breadth of pitch: | 2.4m |
| 9. Inner circle from wickets: | 30 yards (27.4m) |
| 10. Outer circle from wicket: | 5 yards (68.5m) |

Important tournament:

- 1 ICC World Cup
- 2 Asia Cup
- 3 T-20 World Cup.

TABLE TENNIS

Table Tennis is an indoor game. It is played on a table with small racket and a very light plastic ball. Two players or two pairs of players play in the game. One player serves and the other returns the ball. Server or receiver both loses points if the return or service is faulty.

The origin of table tennis is not exactly known. But it was popular in the 19th century England as 'Ping-Pong'. Later it reached other European and Asian countries. The International Table Tennis Federation was formed in 1926 in Berlin, Germany and in same year first World Table Tennis Championship was held in London. Table Tennis Association of India was formed in 1938. It was included in the Asian Games in 1958 and in Olympic Games in 1988. India held the World Table Tennis Championship in 1952, 1984-85 and in 1986-87.

Rules of the Game:

- 1 The order of serving, receiving and ends- It is decided by a draw of lot. The player serving first in the game, receives in the next game of the match.
- 2 The player or pair scoring 11 points first wins the game. But at 10-10 score, a lead of two points is must to win the game, i.e. 12-10, 13-11, 14-12 etc.
- 3 The match consists of best of 5 games for men and best of 3 for women.
- 4 Points- A player loses a point:
 - If he makes a wrong service.
 - If he makes wrong return.
 - If he touches the table with his free hand during the play.
 - If his racket or clothing touches the net during the play.
 - If his body or his clothing touches the ball in the play.
 - If he hits the ball twice in succession.
- 4 Let- A service is Let:
 - If in a good service, the ball touches the net or its supports.
 - If the receiver is not ready.
 - If the game is interrupted due to playing mistake or accident.
 - If any player is warned or penalized.

Specifications of the Playfield & Sports Equipments:

Shape of the table of table tennis	Rectangular
Length of the table	2.74 m
Width of the table	1.525 m
Height of the table from the floor	76 cm
Length of the net	1.83 m
Height of the net from surface of the table	15.25 cm
Diameter of the ball	40 mm
Weight of the ball	2.53 gm
Colour of the ball	white or orange
Material of the ball	Celluloid or plastic
Interval between successive games	1 min
Time out during match	1 min

Width of side lines and end line	2 cm
Width of the line which divides the surface parallel to side lines	3 mm
Colour of the table	Blue or Green (wood/cardboard)
Officials	3(Match umpire, Assistant Umpire, Tournament Referee)

Important Tournaments:

- Asia Cup
- Corbillion Cup (women)
- Olympic Games
- Commonwealth Games

YOGA

The word yoga literally means “to yoke” or “union or join”. More than just a practice of physical exercises, Yoga is the coming together of the individual self or consciousness, with the infinite universal consciousness or spirit. Yoga is a method of inquiry in to the nature of the mind, which emphasizes practice and direct experience.

Yoga was originated in India several thousand years ago. The first book on yoga was written by Patanjali in 147 B.C. In ancient time yoga was taught as a compulsory subject to all students in gurukuls. It was not only a subject but a way of healthy life. Many gurus in ancient period were known for producing mysterious results through their yoga practice. They cured serious and fatal diseases through the practice of Yoga. Even today we often hear amazing news about the cure of some of the incurable diseases and ailments through yoga. This basic of yoga is- our body cures itself through disciplined regulation of our actions and habits. MaharshiPatanjali is the father of modern Yoga.

Basic General Rules to perform Yoga

- 1 Yogic asanas should be performed on a mat or blanket on the ground. The ground should be even.
- 2 The place for yogic practices should be peaceful, airy and clean.
- 3 Breathing should be normal and mind should be at peace while doing yogic exercises.
- 4 Yoga should be performed with concentration of mind at least four hours after taking meals.
- 5 Warm up your body before performing asanas.
- 6 The yogic exercises should be performed slowly and rhythmically.
- 7 The yogic practice should be done under the guidance of an expert.
- 8 Do not take bath immediately after asanas.

Main Advantages of Yoga

Asana	Meditation	Pranayama	Chanting
Helps creates lightness in the physical body and correct imbalances in the physiological body	Inspires the intellect, and engages the mind	Focuses the mind, regulates the movement of prana, life force energy	Penetrates all the bodies and sheaths, koshas, illuminates every part of our being, creating transparency so the light of the soul, atman, can shine brightly though

Some suggested asanas for regular practice are listed below:

- Surya namaskar (complete exercise of whole body)
- Tadasana (to increase the height)
- Bhujansana (to increase digestive power, strengthen the muscles of vertebral column and lungs)
- Dhanurasana (to reduce obesity, power of digestion, strengthen the stomach & intestine)
- Paschimotasana (to provide strength to the thighs, cleanses the blood vessels, removes gas trouble)
- Padmasana (stimulates digestive system, increase concentration, Backache disappears, remove urinary troubles)
- Vajrasana (best exercise to stimulates digestive system, should perform after taking meals)
- Savasana (keeps heart and brain fresh, remove fatigue, control high blood pressure and mental tension)

MODERN OLYMPIC GAMES

The credit to start the modern Olympic Games goes to Baron de Coubertin of France. It was Coubertin's imagination to restart the Modern Olympic Games at world level. For this purpose, he called a meeting of various countries in 1893. Some countries viz. Italy, Greece, Spain and Sweden were in favour of commencing these games, whereas rest of the countries opposed it. Again on June 16, 1894, a meeting of 13 countries was held in Paris in which 75 representatives participated. It was presided over by Coubertin. After much Endeavour's, Coubertin succeeded in enlisting worldwide support and the first modern Olympic Games were held in Athens in 1896. In 1896, Athens Olympic Games, only nine countries participated in the first modern Olympic Games. This number gradually increased and in 1972, Munich (West Germany) Olympic Games 122 countries participated. Three Olympic could not be held due to two world wars.

- **Olympic Motto**

Olympic motto comprises of three Latin words-Citius (Faster), Altius Higher), Fortius (Stronger). The motto was coined by a French educator Father Didon in 1895.

- **Olympic Flag**

Olympic Flag was created in 1913 at the suggestion of Baron de Coubertin. It was first solemnly inaugurated in Paris in June 1914. But it was hoisted first time in the Olympic stadium at the Antwerp Olympic Games which were held in 1920. Olympic flag is made of white silk and contains five interlocking rings/circles in five colours representing five continents of the world viz. America, Europe, Australia, Asia and Africa. The five rings have different colours viz. yellow, green, red, blue and black.

- **Olympic Flame**

The Olympic flame is a symbol of knowledge, life and happiness. It also symbolizes peace.

- **Olympic Awards**

The first, second and third position holders are awarded with gold, silver and bronze medals and a certificate respectively. The next five position holders are also awarded with certificates only.

- **Olympic Oath**

During the opening of Olympic Games oath taking ceremony is held by the athletes who are assembled in the sports stadium. A representative of the host country comes forward holding the flag. The flag bearers of the competing nations also take up their positions. The representatives take oath on their behalf and all the athletes raise their right arm and repeat the oath after him:

“we swear that we will take part in the Olympic Games in loyal competition, respecting the regulations which govern them and desirous of participating in them in the true spirit of sportsmanship for the honour of our country and for the glory of sports.”

SPORTS AWARDS IN INDIA - MAJOR AWARDS

The most important Sports Awards in India is given for the excellence of the sportsperson in sports. The most popular awards in the sports field are - Rajiv Gandhi KhelRatna, Arjuna Award, Dronacharya Award, Dyanchand Award.

1) Rajiv Gandhi KhelRatna (1991-92) - This is the highest sports award in India given for most outstanding performance in the field of sports. • The recipients receive Rs. 7.5 lakhs in cash, a citation and a medal.

Initially, the government of India gave this award for outstanding performance in the field of sports for one year, but this duration was changed to four years in the year 2015. • The government of India forms a committee of 12 members who evaluate the performance of a sportsperson. • The evaluation is done for various international sporting events such as Olympic Games, Asian Games, Commonwealth Games and Paralympic Games. • Once the committee arrives at a decision, they submit their recommendation to the Union Minister of Youth Affairs and Sports for further approval.

2) Arjuna Award (1961) - This award is given to a sportsperson who has consistently exhibited outstanding performance for four years. • All Arjuna Awardees receive a cash prize of Rs. 5 lakhs, a certificate, and statuettes

3) Dronacharya Award (1985)- “Behind every successful sportsperson there is a coach” Seeing the valuable contribution that coaches have in the sports field, the government of India decided to honour the coaches as well. The Dronacharya Awardees are those who have produced medal winners at prestigious international sports events. • Dronacharya Awardees are offered a cash prize of 5 lakh, certificate and statuette.

4) Dyanchand Award (2002)- The Dyanchand Award is given for lifetime contribution to sports development. • This award is named after Major Dhyan Chand, an Indian hockey player who scored over 1000 goals during a career span of over 20 years. • Dyanchand Awardees are offered a cash prize of 5 lakh, certificate and statuette.

DIAGRAMS OF PLAY GROUNDS/ COURTS

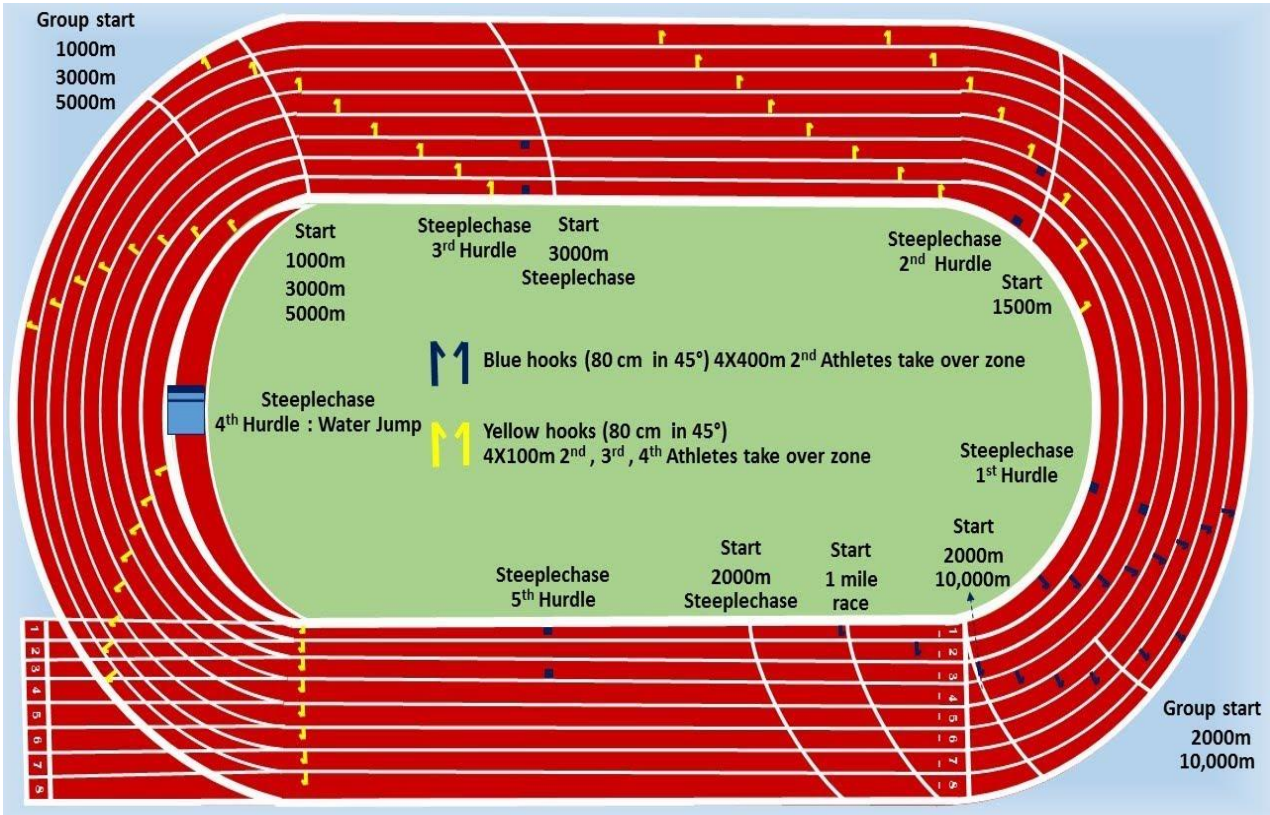

Track & Field

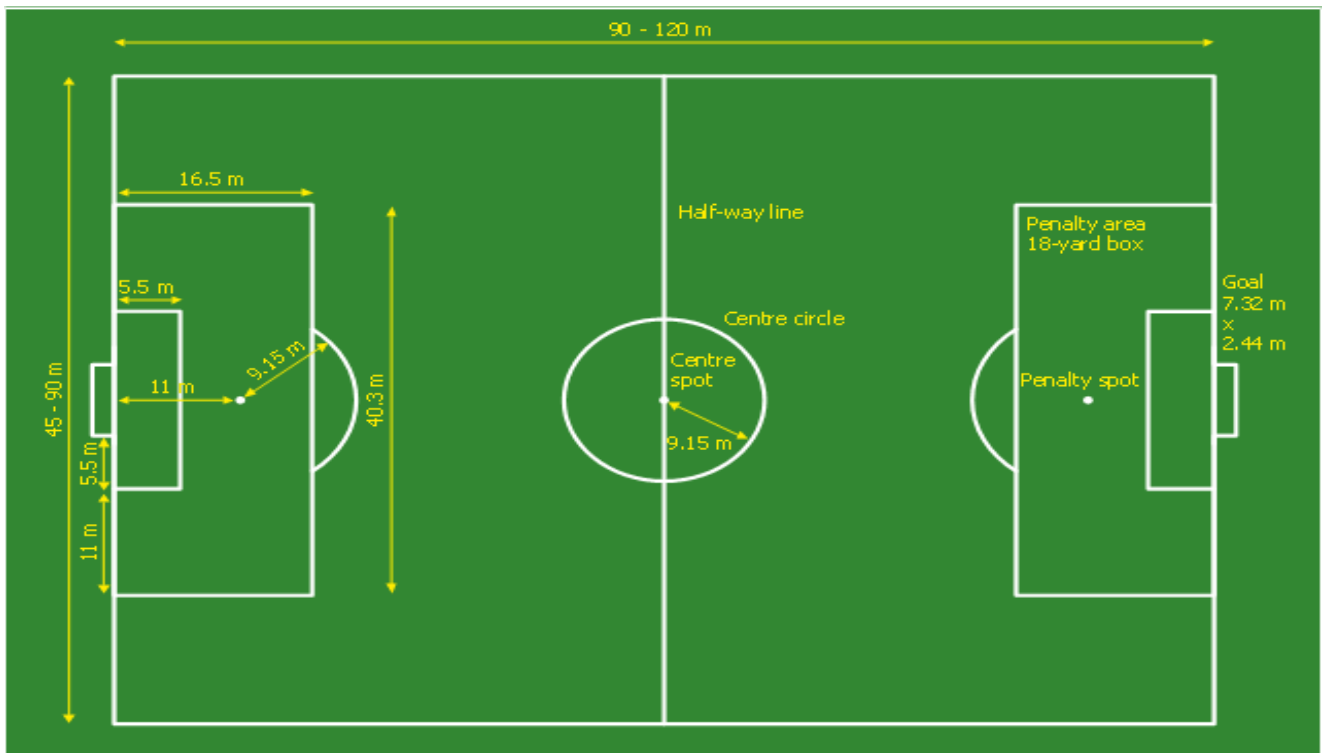

Football Ground

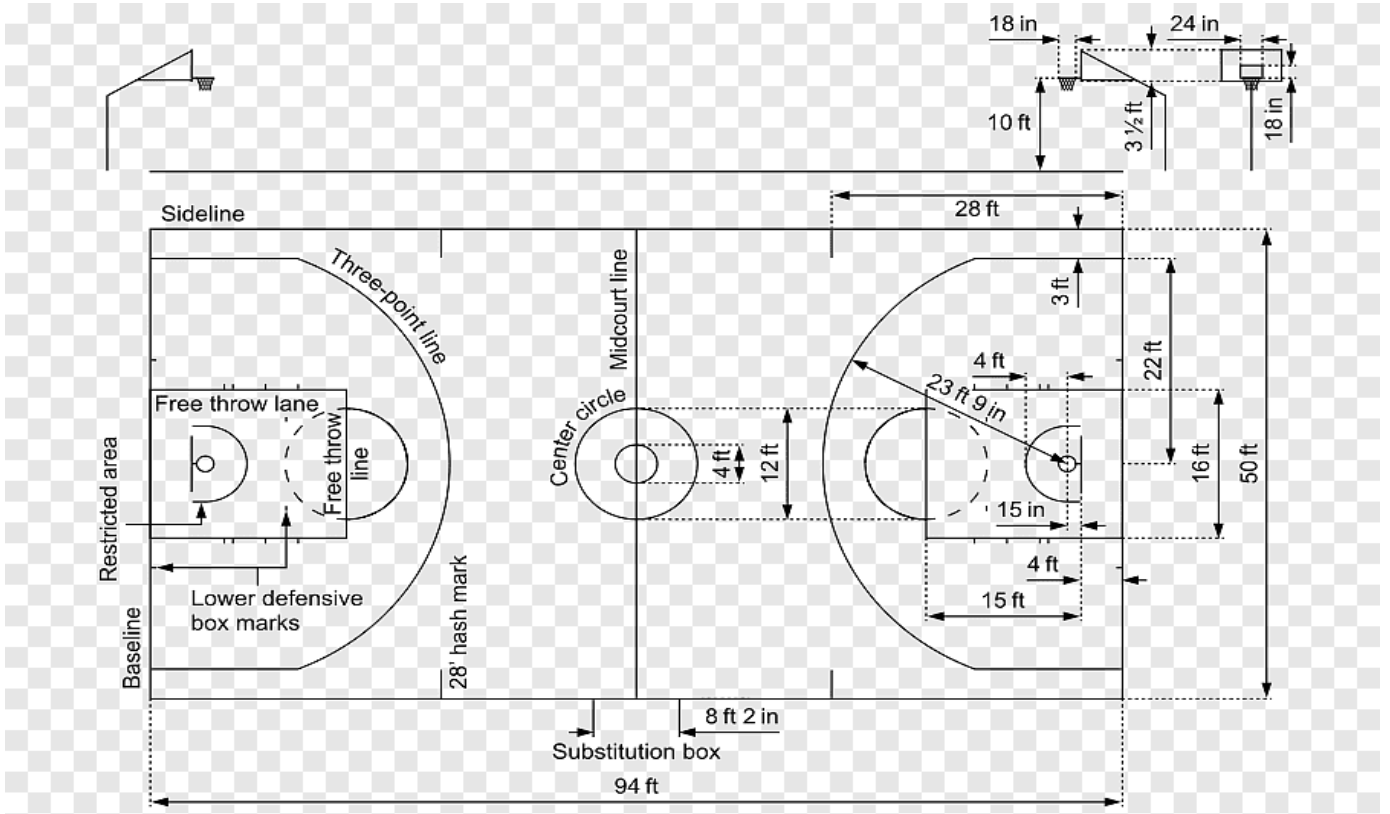

Basketball Court

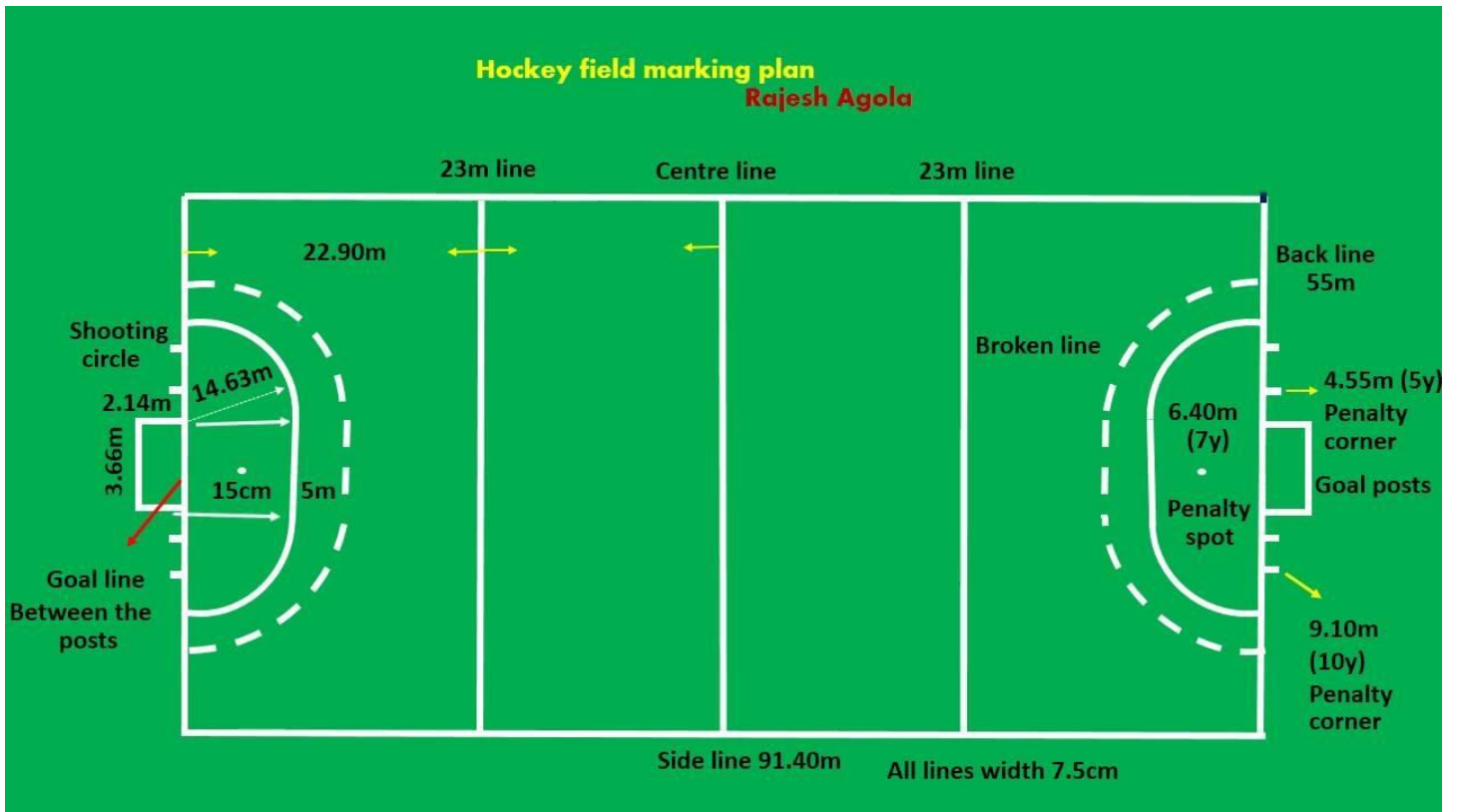

Hockey Court

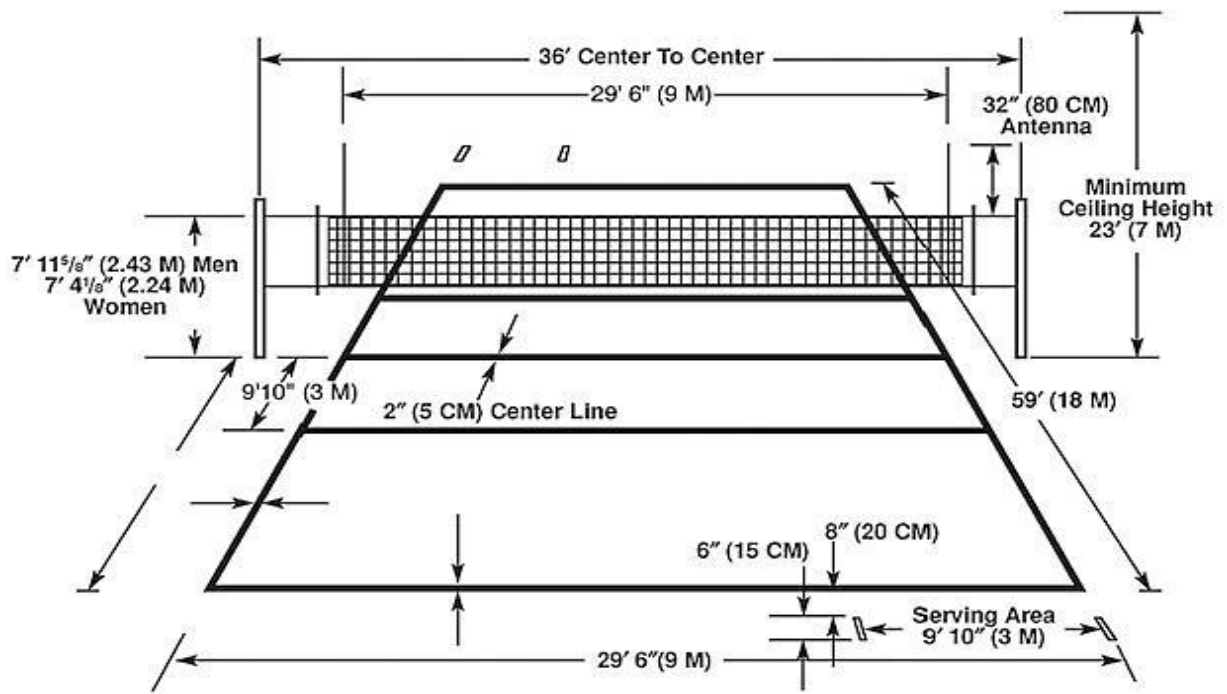

Volleyball Court

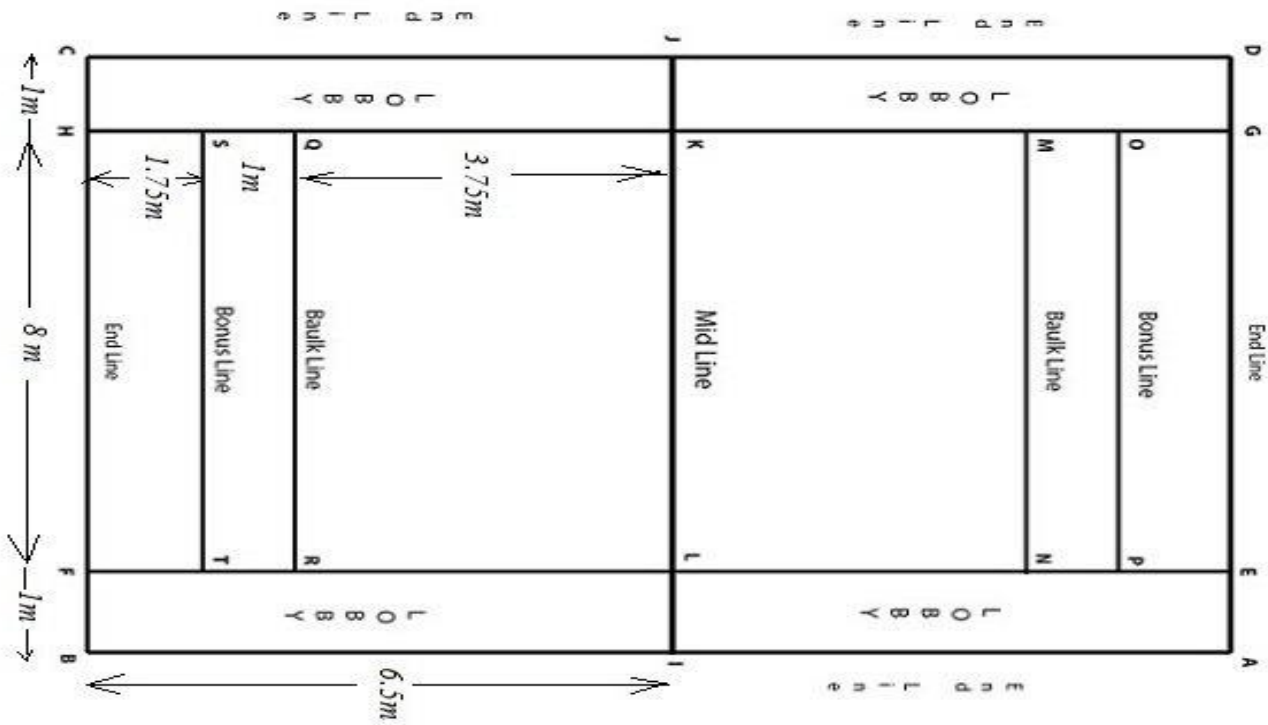

Kabaddi Court

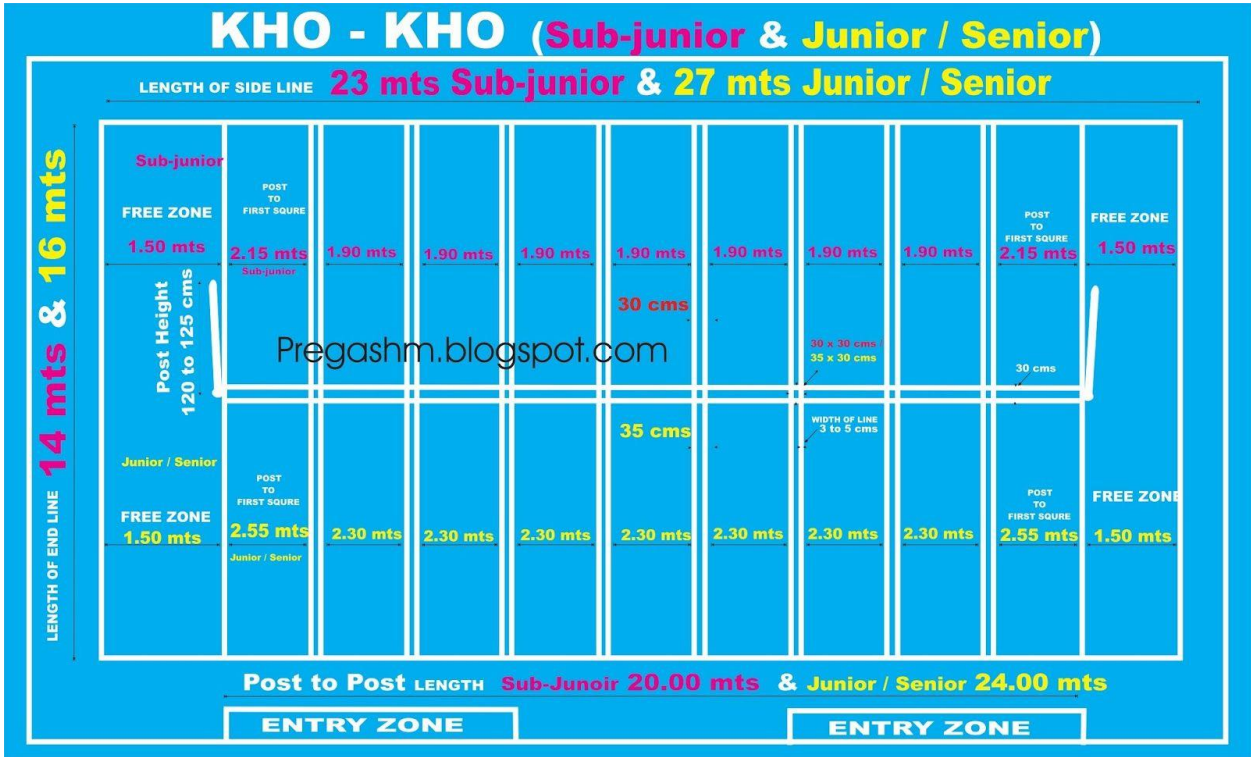

Kho-Kho Court

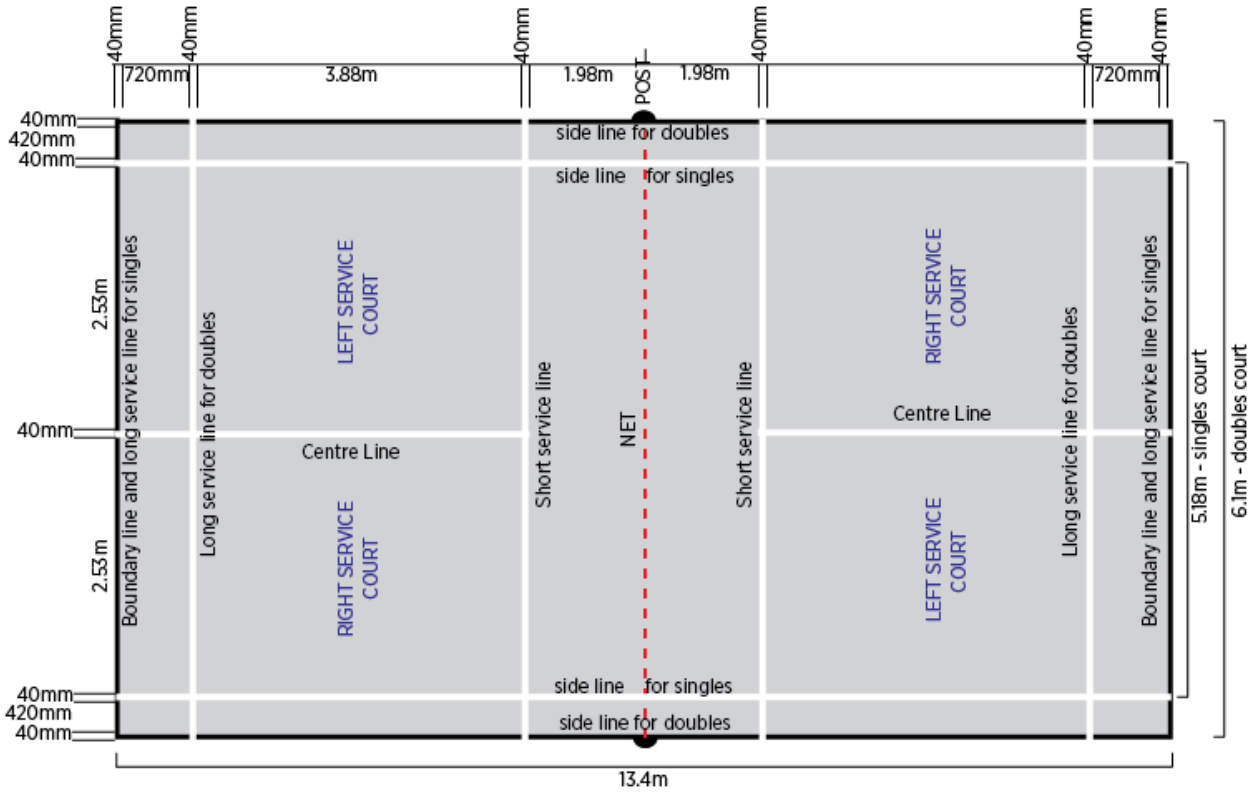

Badminton Court

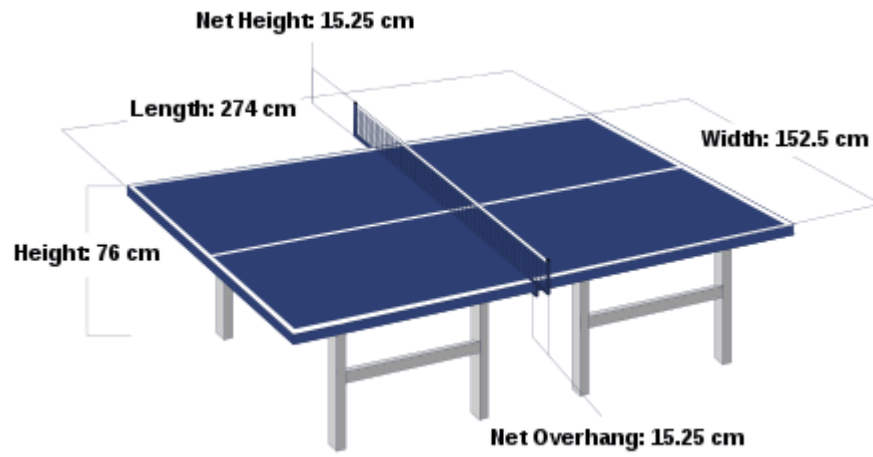
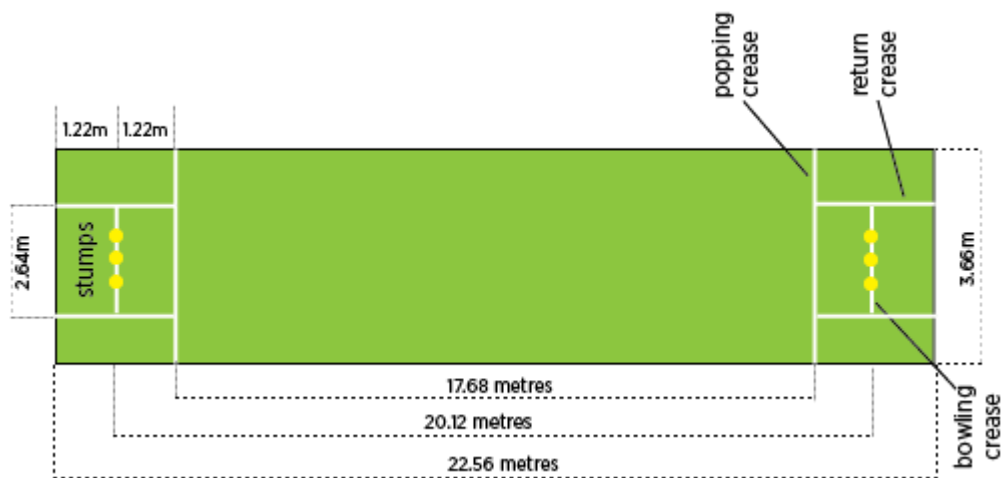
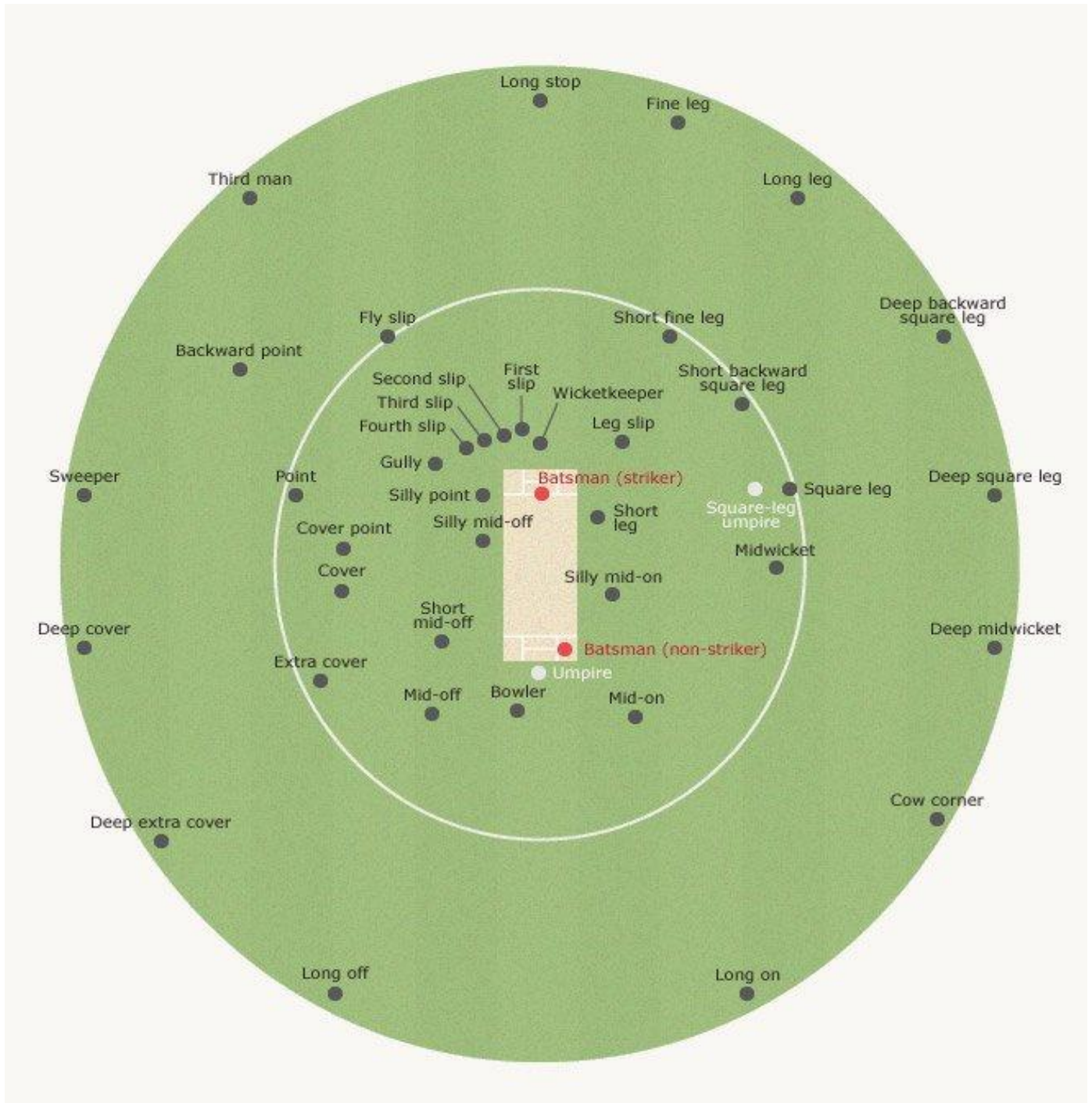

Table Tennis Table



Cricket Pitch



Cricket Ground